

▶ **Stretch  
wrap film**

# Cast Film Lines

Expressive  
design,  
impressive  
technology



**At SML we like to think outside the box. Outstanding technology, exquisite design and a high performance – that's what makes our stretch film lines tick.**

In a highly competitive segment, it is good to know that all the components of a stretch film line in tandem with SML's sizable diameter chill rolls are a guarantee for excellent film qualities. If you add to this the fact that SML is an established market and technology leader, then you have a winning combination.

#### **Create your own experience**

At SML we leave nothing to chance. We analyse your own specific situation and support you in the decision-making process. You have the choice of standard stretch film lines in widths from 3 - 12up (1,500 mm to 6,000 mm) or customised lines developed from our standard products to suit your individual requirements. Triple chamber vacuum boxes, film temperature measurement devices (FTM) and K-AP technology, as well as other components such as these, are integrated in the lines.

#### **Diversity in winding systems**

Inline winding on 2-inch cores for hand stretch film, coreless or shaftless winding systems and thin core technology, together with different numbers of extruders and layers, these are all features that we can provide. An additional device is available to customers for edge modification giving them the possibility to upgrade their machines for light weight handrolls with enforced and indestructible edges.



#### **Highly efficient and comfortable to control**

Customers can operate SML lines with a minimum of manpower thanks to the proven SMILE control system and different grades of automation, in terms of roll and core handling. bitWise, SML's data generation and analysing tool, spurs the constant optimisation of production processes and final products.

Line Description ▶ 8

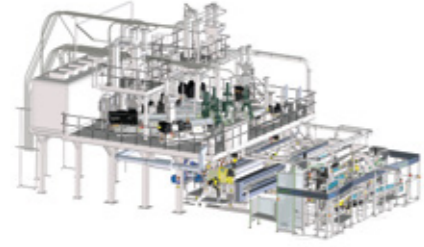

MiniCast® ▶ 10



EcoCompact® ▶ 12

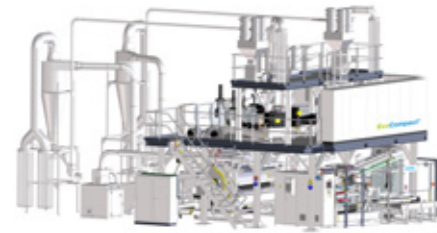

SmartCast® ▶ 14



PowerCast ▶ 16



MasterCast® ▶ 18



Winding Systems ▶ 26

## Stretch wrap film



# The core of our idea: Lines for stretch wrap film

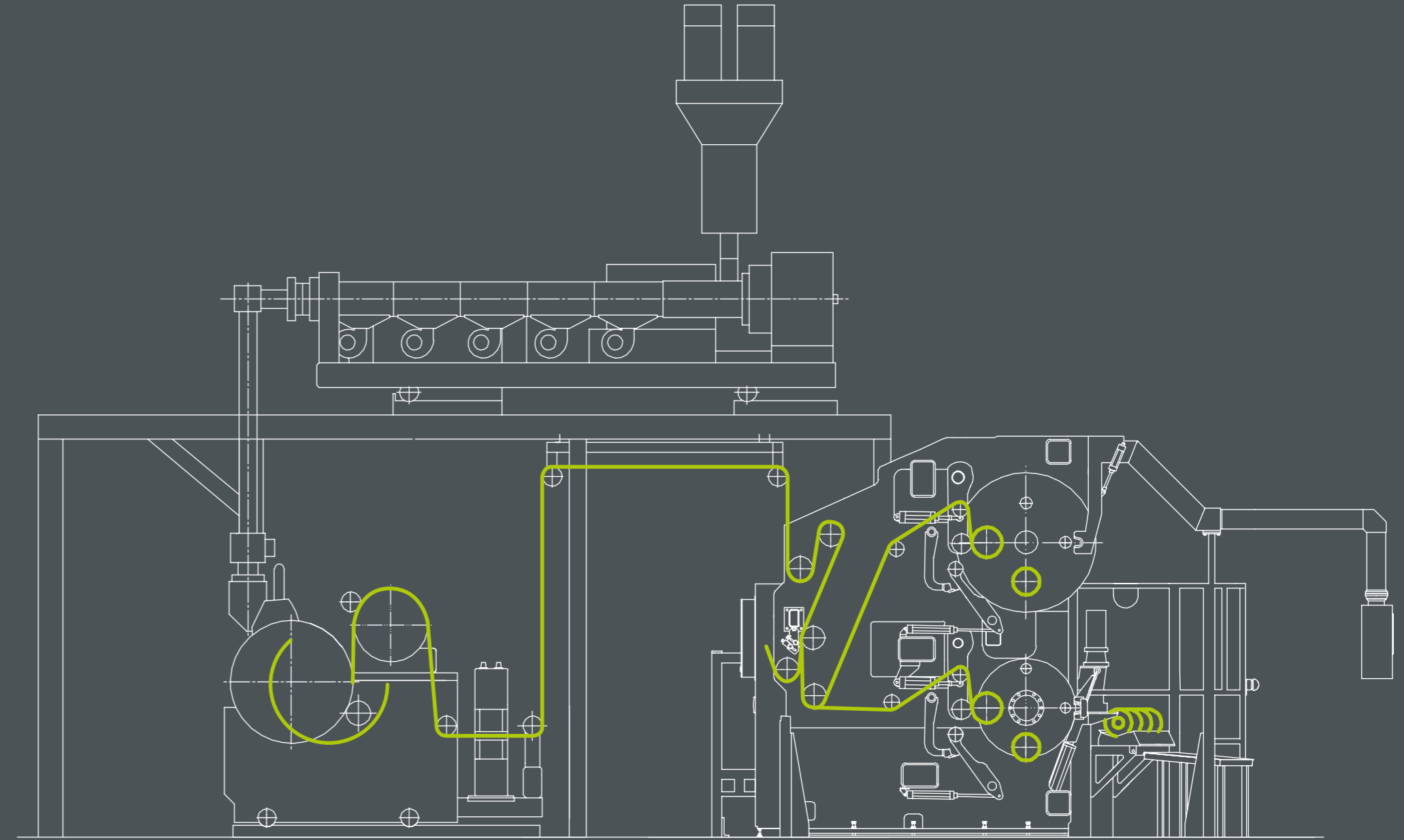

# Overview

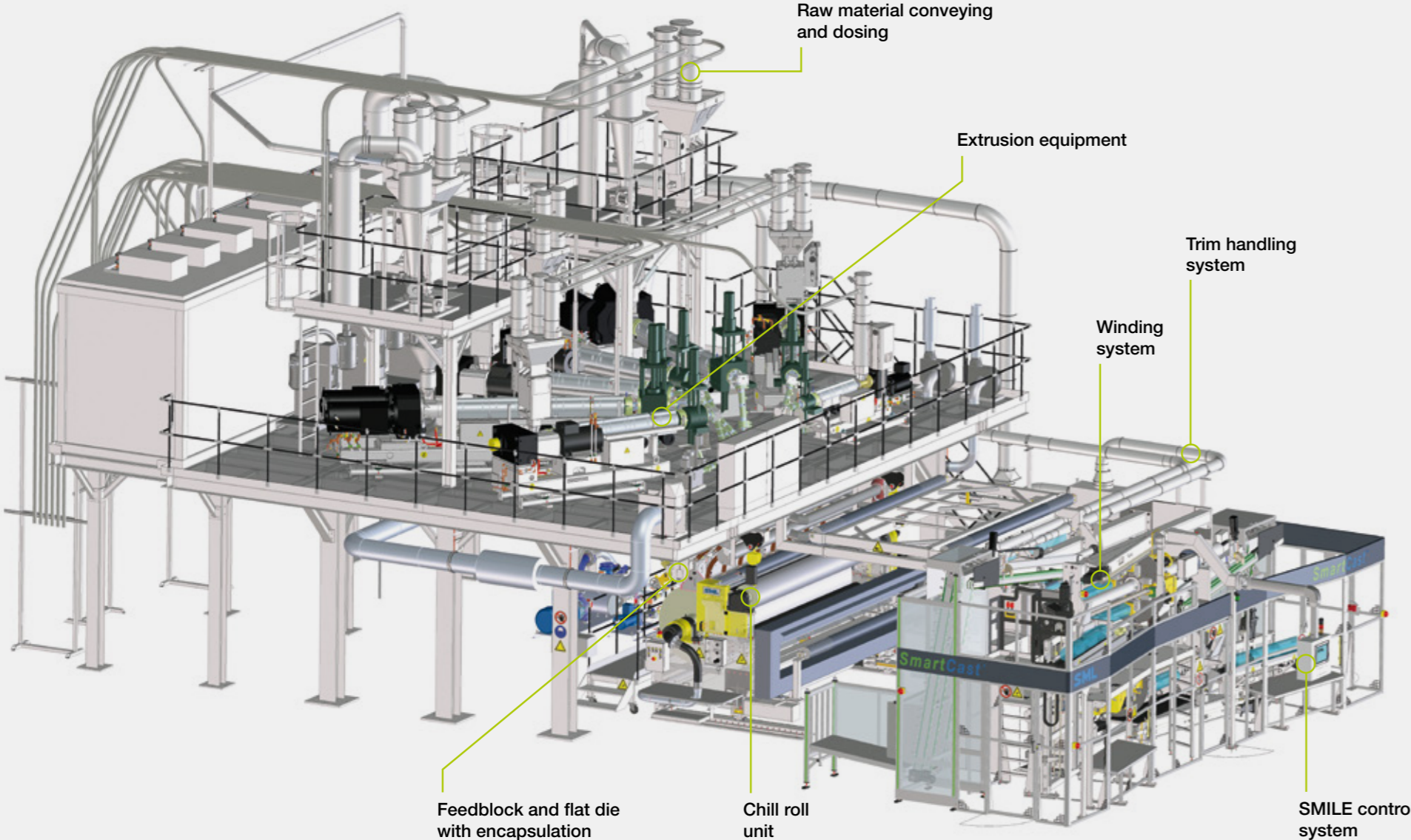

# Products

Pallet stretch wrap film represents the **biggest share of the cast film market**. Compared with all other films used for palletising solutions, it has the **lowest unit wrap weight**.

For that reason, it is the most cost-effective way for the safe packaging of items on pallets. In addition, pallet stretch wrap film is also eco-friendly, since it can be produced from nearly 100 % recycled materials.

### Wide range of different film types

In response to the varied requirements for different transportation methods and distances, a wide range of stretch film qualities has been created and continues to expand. SML extensively uses its in-house testing facilities and its demonstration lines to develop new stretch wrap films in close cooperation with its partners. Today, stretch wrap products extend from simple 3-layer hand films, to machine film grades with very high pre-stretch rates and dart-drop values.

### High volumes, high efficiency

At stretch wrap film production, over 80 % of the production costs relate to raw material. This was SML's primary reason for the development of high-performance stretch wrap film lines with the highest output capacities. In combination with cost-saving formulations, reliable machinery, high safety standards and low waste rates, this guarantees maximum line efficiency and low unit costs.





# MiniCast®

## The space miracle.



Stretch Film Extrusion Line

The *MiniCast*® line stands out as the ideal solution for best production output/line-space ratio.

Although the space requirements of the *MiniCast*® line are pleasingly small, this does not mean that it is more poorly equipped. Up to four extruders can be fit on a minimum floor area of less than 100 sqm which facilitate a combined extrusion throughput of 1,200 – 1,400 kg/h. Pre-manufacturing in lots ensures that *MiniCast*® lines are available within short delivery times.

### Single roll casting station

The machine incorporates a single roll casting station with a chill roll diameter of 1,200 or 1,600 mm and an optical thickness measuring system for translucent films, or an X-ray version for opaque films. Customers can select between edge trim re-feeding via a scraptruder for fluff, or a re-pelletising system.

### Winding of hand, machine and jumbo rolls

SML can always offer the ideal winder type which meets individual needs. In case of the *MiniCast*® line, winders W4000-2S or W4000-4S can be integrated. With a single turret version of the well-known W4000-4S winder, for example, the *MiniCast*® stretch film line guarantees top quality winding of hand rolls on 2-inch cores, as well as machine and jumbo rolls on 3-inch cores.

### Chill roll unit

- ▶ Chill roll Ø 1,200 mm or 1,600 mm, width 2,100 mm
- ▶ X-ray thickness measurement
- ▶ Alternative: IR or Beta sensor
- ▶ Oscillating frame

### Edge trim re-feeding system

The system is equipped with a vertical scraptruder (fluff re-feeding system). Alternative: recycling unit with reel feeder for the pelletising of edge trim and start-up rolls.

### Winder

Depending on the customer's requirements, the winders W4000-2S or W4000-4S can be integrated in the *MiniCast*® line.

### Technical data

Products	super power stretch, machine stretch, hand stretch, cling film	
Film thickness range	8 - 50 µm	
Film final width	3 x 500 mm	
Film structure	3, 5 or 7 layers	
Production speed	up to 650 m/min	
Net output value	12 µm	600 kg/h
	17 µm	845 kg/h
	23 µm / <i>MiniCast</i> ® 3L	900 kg/h
	23 µm / <i>MiniCast</i> ® 5L	1,050 kg/h

### Create your exclusive package

#### Line configuration

<i>MiniCast</i> ® 3L		<i>MiniCast</i> ® 5L	
Gravimetric batch dosing system with 2 components. Option: 3 or 4 components			
3 extruders		4 extruders	
1 x 90/33	800 kg/h	1 x 90/33	800 / 900 kg/h
2 x 60/28	2 x 200 kg/h	3 x 60/28	3 x 200 kg/h
SML advanced heaters for the extruder barrels			
3-layer feedblock		5-layer feedblock	
Automatic flat die: 2,050 mm			

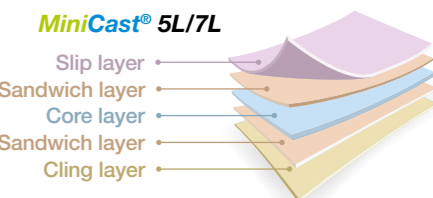
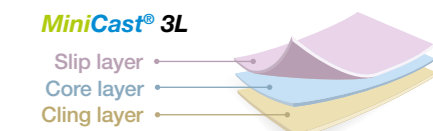



# EcoCompact®

## Compact outside, flexible inside

The EcoCompact® line is your proven entry ticket to top quality stretch film production.

Unexpectedly flexible for its size, the EcoCompact® line enables stretch film production with a width of 2 m (4-up) with extruder outputs of up to 1,600 kg/h. Five different winders can be integrated to get the best and most cost-efficient solution: the winder W4000-2S, W4000-4S, 1T, 2T and W3000-4S. Solutions no other manufacturer can provide! Various final widths of 400, 450, 500 and 1000 mm are possible.

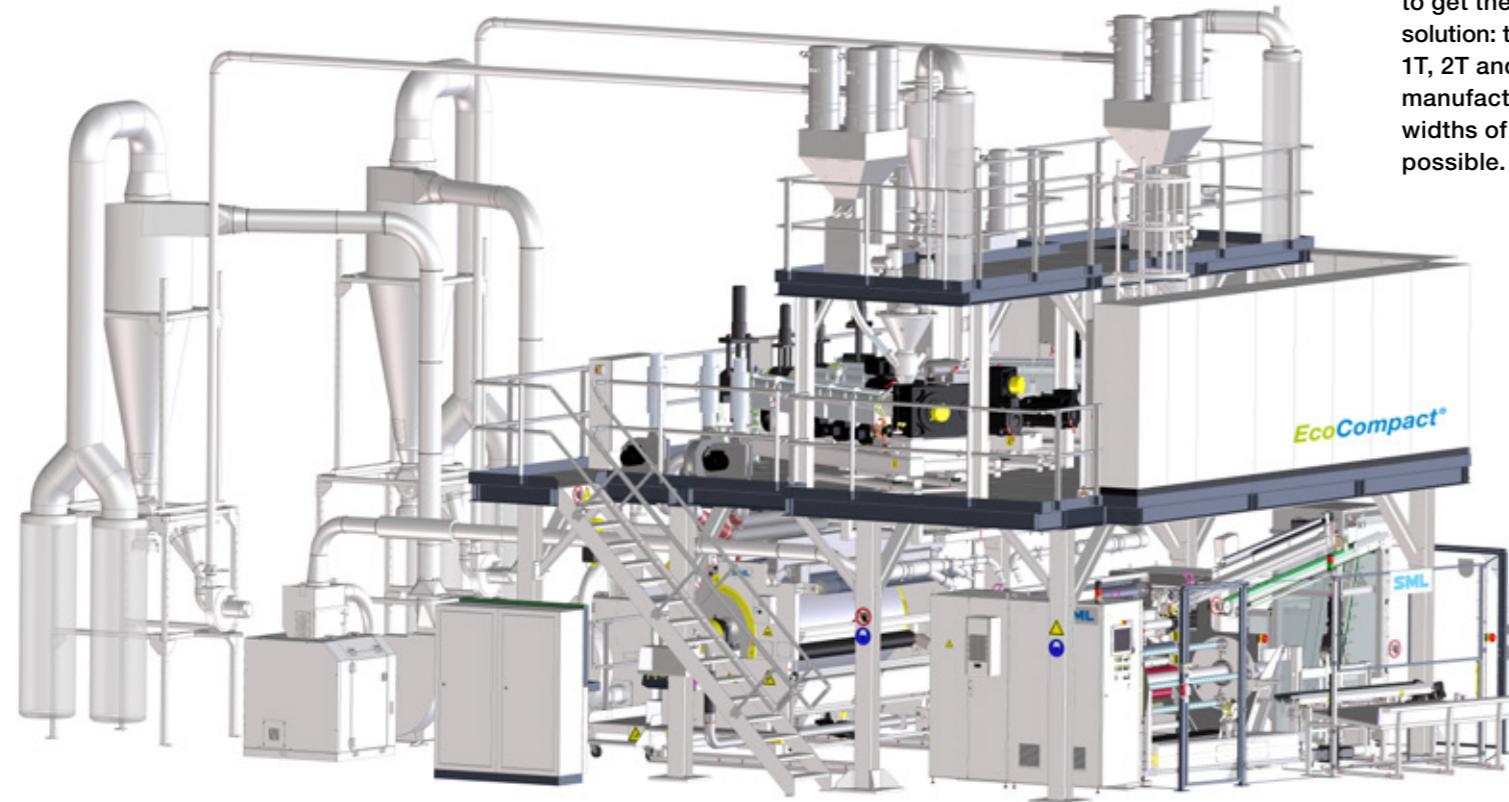

Stretch Film Extrusion Line

### Product changes made easy

For many customers, the EcoCompact® stretch film line is simply the most flexible line. Product changes are easy compared to larger production lines. Quick core diameter changes are another reason to rejoice. SML usually delivers the EcoCompact® line in a three, five or seven layer version.

### Chill roll unit

- ▶ Primary chill roll Ø 1,200 mm or 1,600 mm, width 2,700 mm
- ▶ Optional secondary chill roll Ø 400 mm, width 2,700 mm
- ▶ IR thickness measurement
- ▶ Alternative: X-ray or Beta sensor
- ▶ Oscillating frame
- ▶ Cut-resistant guiding rolls

### Edge trim re-feeding system

The EcoCompact® is a true space-saver requiring only 140 sqm, including an inline recycling system. A reel feeder is integrated in the recycling unit for the pelletising of edge trims and start-up rolls. The alternative is a vertical scraptruder (fluff re-feeding system).

### Winder

Depending on the customer's requirements, the winders W4000-2S, W4000-4S and also the winder W3000-4S can be integrated in the EcoCompact® line.

### Technical data

Products	super power stretch, machine stretch, hand stretch, cling film	
Film thickness range	8 - 50 µm	
Film final width	4 x 500 mm	
Film structure	3, 5 or 7 layers	
Production speed	up to 650 m/min	
Net output value	12 µm	800 kg/h
	17 µm	1,125 kg/h
	23 µm	1,200 kg/h

### Create your exclusive package

#### Line configuration

EcoCompact® 3L	EcoCompact® 5L
<b>Gravimetric batch dosing system with 2 components. Option: 3 or 4 components</b>	
<b>3 extruders</b>	<b>4 extruders</b>
1 x HSE 90/33 950 kg/h	2 x 90/33 each 600 kg/h
1 x 75/33 480 kg/h	2 x 60/28 each 190 kg/h
1 x 60/28 190 kg/h	
<b>SML advanced heaters for the extruder barrels</b>	
3-layer feedblock	5-layer feedblock
Automatic flat die: 2,600 mm	

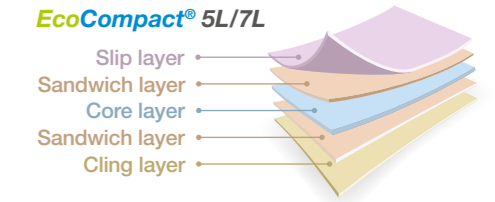
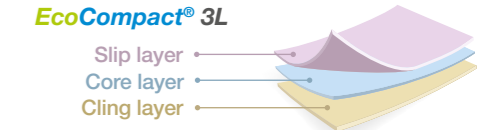



# SmartCast®

The all-time favorite.  
Each and every time.

The *SmartCast®* brand stands for a 3 m wide (6-up) machine which produces stretch film at a top performance level and with the greatest of variety.

The *SmartCast®* line's great popularity can be explained by its numerous features. Its modular system consisting of four pre-configured extrusion units is quite remarkable. Outputs ranging from 1,900 to 3,000 kg/h add to its appeal. Clients can choose between five or seven layers which simplifies customising to meet individual requirements.



Stretch Film Extrusion Line

## Production speeds up to 750 m/min

Production speeds of up to 750 m/min are feasible on account of the edge encapsulation system. This provides an output on the winder of over 1,400 kg/h of 12 µm film.

## Vibration-free chill roll unit

Apart from the new generation of standard and high-speed extruders, SML has also upgraded the chill roll unit adding additional functions and avoiding vibrations. This special highlight allows for a 100 % reproducible casting position. All of the process parameters can be repeated again and again.

## Chill roll unit

- ▶ Primary chill roll Ø 1,200 mm or 1,600 mm, width 3,800 mm
- ▶ Optional secondary chill roll Ø 400 mm, width 3,800 mm
- ▶ Automatic positioning
- ▶ IR thickness measurement
- ▶ Alternative: X-ray or beta sensor
- ▶ Oscillating frame
- ▶ Cut-resistant guiding rolls

## Edge trim re-feeding system

The recycling unit is equipped with a reel feeder for the pelletising of edge trims and start-up rolls. The alternative is a vertical scraptruder (fluff re-feeding system).

## Winder of your choice

Depending on your requirements, the winders W4000-2S, W4000-4S or W3000-4S can be integrated in the *SmartCast®* line.

## Technical data

Products	super power stretch, machine stretch, hand stretch, cling film	
Film thickness range	8 - 50 µm	
Film final width	6 x 500 mm	
Film structure	5 or 7 layers	
Production speed	up to 750 m/min	
Net output value <i>SmartCast® XL</i>	12 µm	1,400 kg/h
	17 µm	2,000 kg/h
	23 µm	2,400 kg/h



### SmartCast® 5L

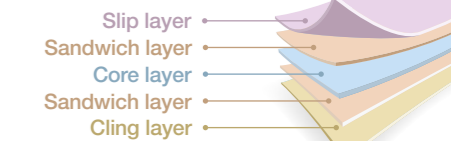

### SmartCast® 7L

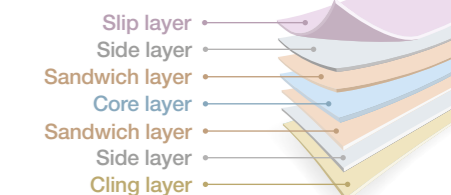

## Create your exclusive package

### Line configuration

<i>SmartCast® S 5L</i>	<i>SmartCast® M 7L</i>	<i>SmartCast® L 5L</i>	<i>SmartCast® XL 7L</i>
Gravimetric batch dosing system with 2 components. Option: 3 or 4 components			
5 extruders	6 extruders	5 extruders	6 extruders
2 x 90/33 each 600 kg/h	2 x 90/33 each 750 kg/h	2 x HSE 90/33 each 950 kg/h	2 x HSE 90/33 each 950 kg/h
1 x 75/33 480 kg/h	4 x 60/28 each 240 kg/h	1 x 90/33 600 kg/h	4 x 75/33 each 300 kg/h
2 x 60/28 each 240 kg/h	2 x 75/33 each 300 kg/h		
SML advanced heaters for extruder barrels			
Edge encapsulation extruder 45/28D (optional)			Edge encapsulation
5-layer feedblock	7-layer feedblock	5-layer feedblock	7-layer feedblock
Automatic flat die: 3,800 mm			





# PowerCast

Let us introduce you to pure power.

The PowerCast® is just what the market needs. It can operate with 4 m and 4.5 m widths and its versatility to handle 3-inch hand, machine and jumbo rolls at high production speeds has yet to meet its match.



Stretch Film Extrusion Line



## Advanced extrusion system

The latest generation of SML's High Performance Extruders (HSE) features strongly in this system. Customising is easy with this standardised system with three pre-configured extrusion units at throughputs ranging from 2,400 kg/h to 4,200 kg/h and the choice between 7 to 67 layers to meet individual requirements. In addition, the PowerCast line is fitted with a chill roll unit using a 1,600 mm diameter C1 roll, guaranteeing the system runs smoothly and without any vibrations.

## Engineered for perfect production results

Using the optional edge encapsulation system, production speeds of up to 850 m/min are feasible, which provides an output on the winder of over 2,000 kg/h of 12 µm film. Quick changeovers for different roll widths are easy with the winder W4000-4S. 400/450/500 mm and 750 mm are a simple task with the XL version, without using a decking or a wider edge trim.

## Chill roll unit

- ▶ Primary chill roll Ø 1,600 mm, width 5,000 mm
- ▶ Chill roll Ø 400 mm, width 5,000 mm
- ▶ Automatic positioning
- ▶ IR thickness measurement
- ▶ Alternative: X-ray or Beta sensor
- ▶ Oscillating frame
- ▶ Cut-resistant guiding rolls

## Edge trim re-feeding system

The recycling unit is equipped with a vertical scraptruder (fluff re-feeding system). The alternative is a recycling unit with a reel feeder for the pelletising of edge trims and start-up rolls.

## Winder: the ideal fit

The winders W4000-2S or W4000-4S can be integrated in the PowerCast® lines as required.

## Technical data

Products	super power stretch, machine stretch, hand stretch, cling film	
Film thickness range	8 - 50 µm	
Film final width	8 x 500 mm, 9 x 450 mm, 10 x 400 mm	
Film final width triple turret winder	9 x 500 mm, 6 x 750 mm	
Film structure	7 or 67 layers	
Production speed	up to 800 m/min	
Net output value PowerCast	12 µm	1,400 kg/h
	17 µm	2,000 kg/h
	23 µm	2,400 kg/h

## PowerCast® 7L

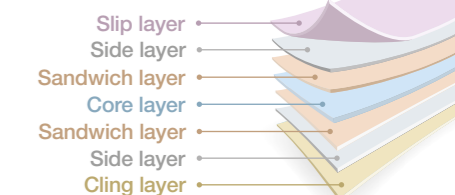

## Create your exclusive package

### Line configuration

PowerCast® S	PowerCast® L	PowerCast® XL
Gravimetric batch dosing system with 2 components. Option: 3 or 4 components		
7 extruders	7 extruders	7 extruders
2 x 90/33 each 600 kg/h	2 x 90/33 each 950 kg/h	2 x 90/33 each 950 kg/h
5 x 60/28 each 240 kg/h	5 x 75/33 each 380 kg/h	4 x 75/33 each 450 kg/h
SML advanced heaters for extruder barrels		
Edge encapsulation extruder 45/28D		
7-layer feedblock (optional 9, 11, 13, 55, 67 layers)		
Automatic flat die: 4,800 mm		5,400 mm



# MasterCast®

## Stepping up the game with unreached volume

The manufacture of machine rolls in large quantities with maximum efficiency requires production lines with exceptional output ranges – the *MasterCast®*.



Stretch Film Extrusion Line

The *MasterCast®* line from SML is the largest cast film extrusion line of its kind and is characterised by its enormous performance. The numbers speak for themselves: *MasterCast®* enables production with a width of 6 meters (12-up) and an installed extrusion capacity of up to 5,000 kg/h. These facts underpin its uniqueness in the world.

### Efficiency in excellence

A production line on this scale offers an unbeatable ratio with regard to the investment costs per kg of output, minimised labor costs and optimum energy use. As a result, it is the most efficient system you can imagine.

### Five or seven layer version

Equipped with proven SML components, this line is offered in a five and a seven layer version. In combination with the fully automatic triple turret winder W4000, the *MasterCast®* sets new standards for the mass production of stretch wrap films.

### Chill roll unit

- ▶ Primary chill roll Ø 1,200 mm or 1,600 mm, width 7,000 mm
- ▶ Secondary chill roll Ø 600 mm, width 7,000 mm
- ▶ IR thickness measurement
- ▶ Alternative: X-ray or Beta sensor
- ▶ Oscillating frame
- ▶ Cut-resistant guiding rolls

### Edge trim re-feeding system

The recycling unit is equipped with a reel feeder for the pelletising of edge trims and start-up rolls. The alternative: a vertical scraptruder (fluff re-feeding system).

### Winder

Depending on the requirements, the winders W4000-2S or W4000-4S can be integrated in the *MasterCast®* lines.

### Technical data

Products	super power stretch, machine stretch, standard stretch	
Film thickness range	(8) 10 - 50 µm	
Film final width	12 x 500 mm	
Film final width triple turret winder	9 x 500 mm, 6 x 750 mm	
Film structure	5 or 7 layers	
Production speed	up to 650 m/min	
Net output value	12 µm	2,400 kg/h
	17 µm	3,300 kg/h
	23 µm	4,000 kg/h

### Create your exclusive package

#### Line configuration

MasterCast® 5L	MasterCast® 7L
Gravimetric batch dosing system with 2 components. Option: 3 or 4 components	
5 extruders	6 extruders
2 x 150/33 each 1,250 kg/h	2 x 150/33 each 1,250 kg/h
1 x 135/33 1,050 kg/h	4 x 90/33 each 600 kg/h
2 x 90/33 each 600 kg/h	
SML advanced heaters for the extruder barrels	
5-layer feedblock	7-layer feedblock
Automatic flat die: 6,950 mm	



#### MasterCast® 5L

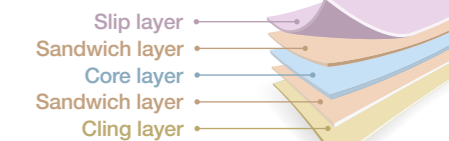

#### MasterCast® 7L

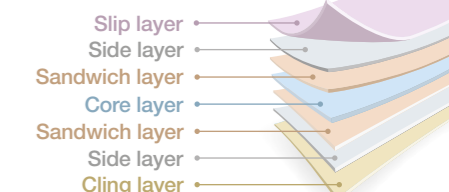



Dosing unit

## Handling with great accuracy Raw material

SML offers a wide range of gravimetric batch blenders and continuous gravimetric feeders with up to six components per extruder. Applying these systems enables recipes to be run with a great accuracy and repeatability. The complete dosing unit, as well as all the material supply vacuum pumps, filters, and valves are fully integrated in SML's machine control system SMILE.



## Operating at an advanced level Extrusion equipment

All of the SML stretch film extruders are designed to handle a wide range of polymers used in this market. A choice of standard versions with 45 – 180 mm screw diameters and a 90 mm high-speed version are available. The extruders with an L/D ratio of 28 or 33 and bimetallic barrels are driven by energy-efficient, water-cooled AC motors as a standard feature.

### Highly advanced screw design

Although stretch wrap film is regarded as a commodity, the screw design is highly sophisticated. For example, hardened flanks, barrier, shearing and mixing zones are all employed inline with the layer characteristics, such as slip, cling or functional layers and the polymers utilised in the extruder. Today, apart from standard LLDPEs in C4, C6 or C8 quality, an increasing number of mLLDPEs, widely spread MFIs and even other polymers such as PP are being used in stretch film production.

### Heating system with gravity-closing flap

The extruder barrel of all extruder types is heated with the SML advanced heating system. A gravity-closing flap prevents the escape of hot air from the system, thus retaining the heat in the barrel. Effective melt filtration for the removal of impurities, un-melted or cross-linked particles, is extremely important. SML installs manual or hydraulic piston filters in its stretch film lines.

### Extruder characteristics

	45/28	60/28	75/33	90/33	HSE90	120/33	135/33	150/33	180/33
<b>Screw rpm</b>	289	272	294	226	350	146	139	139	114
<b>No. of zones</b>	3	4	5	5	5	6	7	8	9
<b>Output in [kg/h]*</b>	95	240	480	600	950	950	1,050	1,250	1,600

\* For reference only. Depending on the drive power installed, actual output may differ.

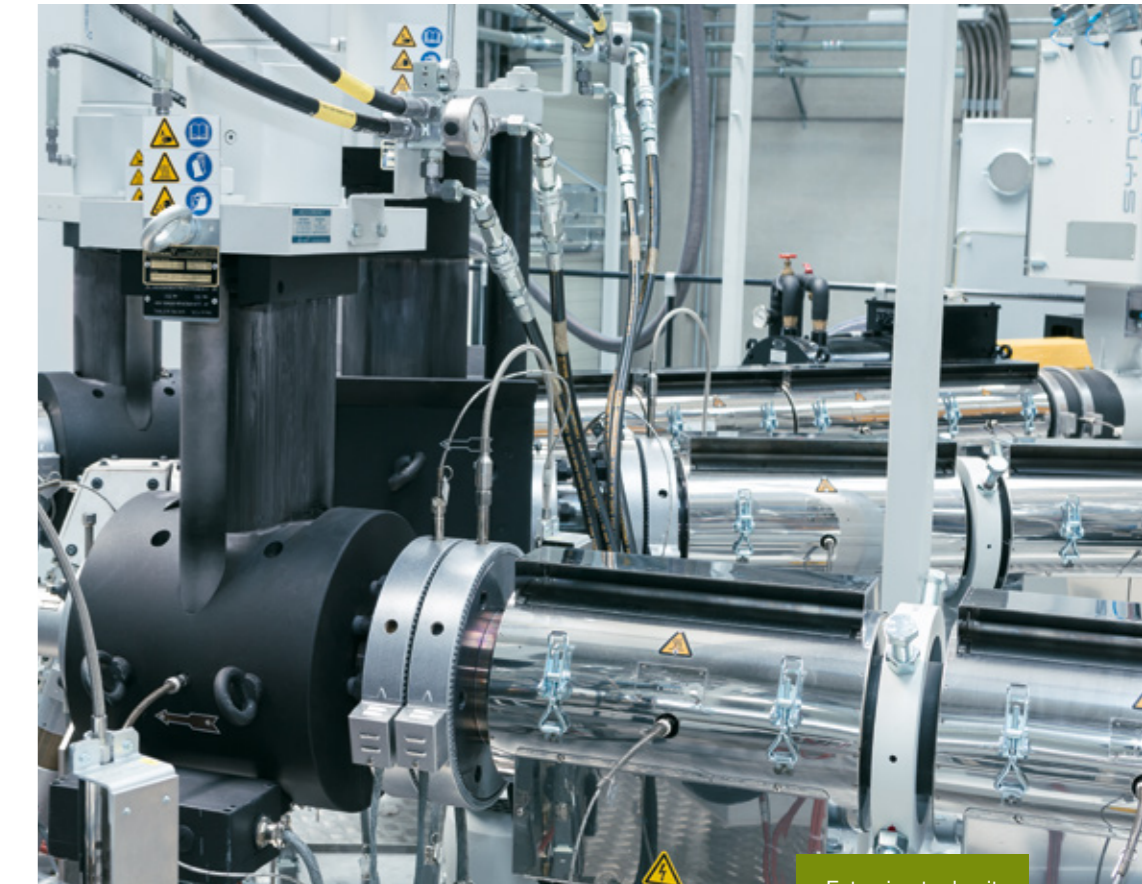

Extrusion tool unit

# Quick and safe Feedblock and flat die



As the leading supplier of stretch film lines, SML relies exclusively on respected partners for its feedblocks and flat dies. The stretch film production trend is towards more sophisticated film structures with a higher number of layers than in the past. This is mainly related to the higher number of extruders used for these films.

## Ready for multiple layers

Today, five, seven or even 13 layers have become standard. Co-extrusion flat dies with T-channels are capable of incorporating fixed or variable internal deckling systems. This feature provides an efficient means of varying the net film width. Depending on the manufacturer, dies are either chrome or nickel plated, but in both cases, automatic die-control via thermally heated bolts is standard.

## SML nano 67: refined stretch film production at its best

On request, SML builds lines with more layers, utilising MicroLayer or NanoLayer™ technology. The specific design boosts film performance in terms of elongation, puncture and tear propagation. A unique layer sequence and extruder combination make it possible to get the best out of every material used and deliver unsurpassed film quality. SML nano 67 is available on SmartCast, PowerCast and PowerCast XL.

## Anything but ordinary: the Reflex die

In 2019 a new standard in stretch film was born: the Reflex die. Fast die control as well as, quicker and more efficient production changes are just a few advantages over conventional die design. Fast and accurate die control combined with SML Booster technology enable the operator to run the equipment in touchless mode.

## Edge encapsulation system

SML suggests edge encapsulation especially for the production of thin film at high line speeds. An additional extruder feeds a divided melt stream of LLDPE to the edges of the die. Edge encapsulation stabilises the melt curtain and thus reduces the danger of trim loss during production. A return on the additional investment required for the edge encapsulation system is obtained very quickly, as the downtimes caused by edge breaks during conventional production are avoided and higher production speeds are possible.

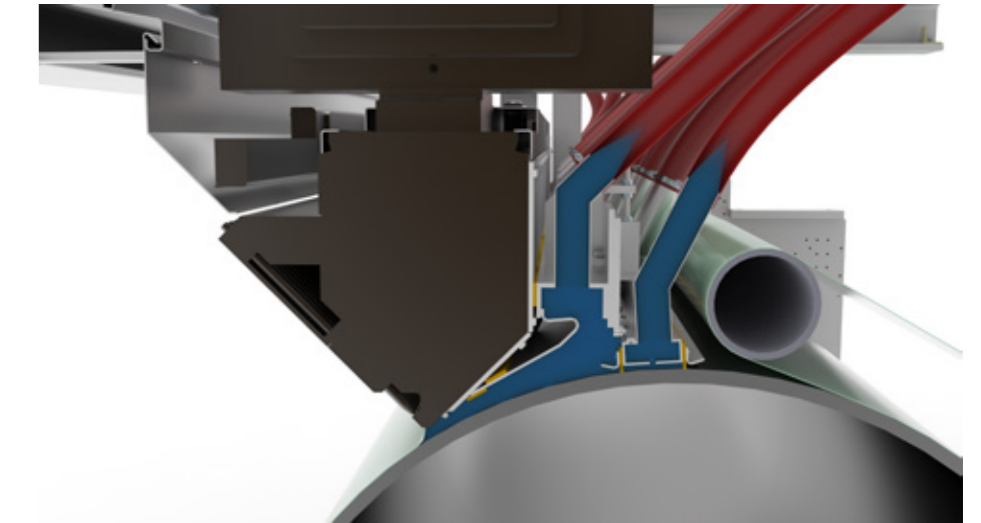

Bi-vacuum box

## Die splitting system

SML's die splitting system enables quick and safe die opening for cleaning purposes. The die remains in its original position in the machine and continues to be heated.

## Edge pinning

A combined electrostatic and pneumatic pinning system fixes the film to the chill roll surface. The adjustable static power and air pressure, as well as easy positioning, allow precise pinning and therefore an excellent film edge contact on the chill roll.

## Vacuum box

The vacuum box, mounted directly on the die body, consists of two or three chambers. The prechamber extracts the air stream caused by the rotating chill roll, while the main chamber maintains a low air pressure between the extruded film and the chill roll. The third chamber is at the left and right end of the box. It takes special care of the edges of the film. In addition, the length of the melt curtain can be adjusted before it touches the chill roll. All of the chambers are equipped with separate speed-controlled suction fans.

# Highly effective Chill roll unit

Apart from the extrusion section in combination with the vacuum box, the condition of the chill roll unit has a significant influence on the final product quality. Parameters such as the position relative to the flat die, the chill roll temperatures and surface have a direct effect on the film. In this connection, the vast experience obtained by SML with the delivery of a large number of stretch wrap film lines facilitates the rapid determination of the optimum parameters for specific customer requirements.



Chill roll unit

## Chill rolls with specified surface properties

The chill roll unit consists of one or two cooling rolls for which careful surface selection is vital. The electro-chemically matted surface of the first chill roll provides an extremely homogeneous surface and a very high cooling capacity. Furthermore, this surface allows easy relieve of the film from the chill roll due to a well-positioned guide roller. The second chill roll has a polished surface for highly effective stretch film post-cooling. Both rolls are chromium-plated and equipped with separate water tempering systems and drives.

## Economic film thickness regulation

SML places the thickness gauging unit directly on the chill roll frame behind the chill roll. The shortest achievable distance from the die lip to the measuring point ensures minimum reaction times for extremely economic film thickness regulation. In response to local regulations in customer countries and specific product needs, SML supplies automatic gauging systems either with infrared, X-ray or Beta-ray sensors.

After leaving the chill roll, the film is transported to the winder via cut-resistant guiding rolls. These have a specially-hardened surface for a high film grip and a long service life!



Fluff re-feeding unit

# This is how economic production works Trim handling system

Stretch film production is only economical with complete trim recycling. With SML's stretch wrap film lines, the edges are cut off directly at the winder entrance and, depending on the winding system, bleed trims are also removed. Fluff and pellet re-feeding are the two possibilities for integrating edge and bleed trims back into the process. In both cases, a blower system transports the trims, either to the grinder in the fluff re-feeding system, or directly to the recycling unit.

## Fluff re-feeding

In the fluff re-feeding system, the trims are sucked through a grinder and then transported to a vertical scraptruder. This feeds the fluff together with virgin material directly to an extruder to form a core layer. Fluff re-feeding is the more energy-efficient and material-compatible method, as no additional melting is involved.

## Pellet re-feeding

At pellet re-feeding, the trim is melted and re-pelletised in a separate recycling unit and then sucked to the dosing system of an extruder. This process offers greater flexibility regarding the use of recycled pellets on different extrusion lines. It is a convenient solution in case frequent color changes are required and for the recovery of waste and off-spec rolls.

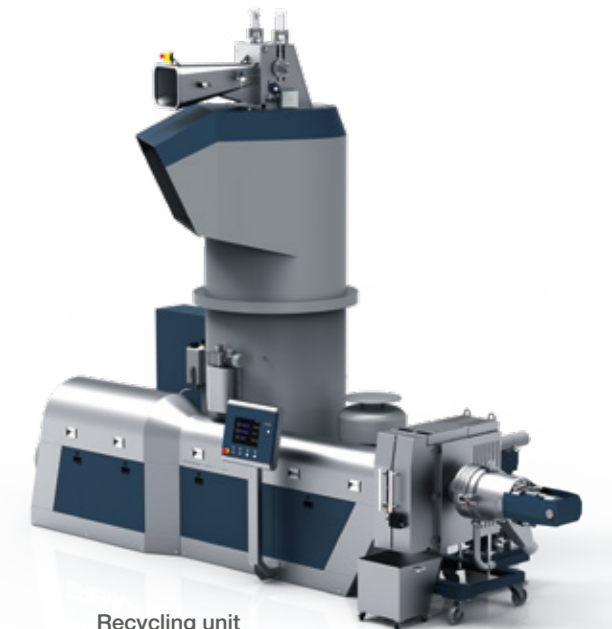

Recycling unit

# The heart of a stretch film line

## Winding systems

The winder is the heart of a stretch film line and decisive in terms of the overall line performance. Before entering the winder, the film is oscillated in an overhead positioned frame in order to ensure a perfect film roll surface. Both the oscillation distance and the speed are adjustable.

### Constant upgrades

SML is proud of its peak performance winders, which are the result of many years of intensive, in-house technological development work. Every new product, idea or requirement, which is spotted in the market, or is the subject of a customer inquiry, is passed on to the R&D department. Following a detailed evaluation, SML then upgrades its winders with corresponding, new features.

### Three different winding solutions

SML has created three different winding systems for the production of stretch wrap film. All of these have a solid, vibration-free steel frame construction, which can resist the dynamic forces generated at high production speeds.

# Find the right winder for your application

Winding	winder W3000-4S	winder W4000-2S	winder W4000-4S
Thickness range	8 - 35 µm	8 - 50 µm	8 - 50 µm
Max. mechanical speed	650 m/min	850 m/min	850 m/min
Winding width	4 - 6 x 500 mm	3 - 12 x 500 mm	3 - 9 x 500 mm
Part roll width	400, 450, 500 mm	variable	variable
Winding on 2-inches	yes	no	yes
Winding on 3-inches	yes	yes	yes
Coreless winding	no	yes	yes
Max. mechanical diameter 2-inches	180 mm	no	180 mm
Max. mechanical diameter 3-inches	400 mm	425 mm	425 mm
No. of winding stations per turret	4	2	4
No. of winding turrets	single	single / double / triple	single / double / triple
No. of winding shafts	shaftless	2 / 4 / 6	4 / 8 / 12
Minimum cycle time	20 s	60 s	20 s
Film tail	very short	standard	ultra short
Bleed trim	bleed trim-free	yes	yes
Winding tension	00 - 100 N/m	00 - 100 N/m	00 - 100 N/m
Contact roll pressure	50 - 500 N/m	50 - 500 N/m	50 - 500 N/m
Core and roll handling manual	no	optional	optional
Core and roll handling automatic	yes	yes	yes

# „Shaftless“ winder W3000-4S

The incoming film is simply cut by single blades to the final film width, e.g. 6 x 500 mm, and then passes an equal number of separation frames.

## Unique winding system

Directly after the satellite roll, the film is wound onto the winding core via a driven contact roll. This core is only clamped by special chucks and not supported by a winding shaft. Therefore, the winder is unique, as it is shaftless and thus offers the major advantage of no critical revolution speeds due to dynamic deflections. Nevertheless, the winder still has a turret with four winding stations for extremely short cycle times and a perfect winding quality up to the end of the roll with an ultimate short tail.

## Thin core technology

These features are supported by an additional contact roll, which follows the roll along the cutting index.

## Your Advantages

- ▶ Bleed trim-free, highly effective material usage
- ▶ For 2-inch and 3-inch cores
- ▶ Extremely short cycle times

This highly sophisticated winder does not produce bleed trims and thus utilises the extruded film in a most effective manner.

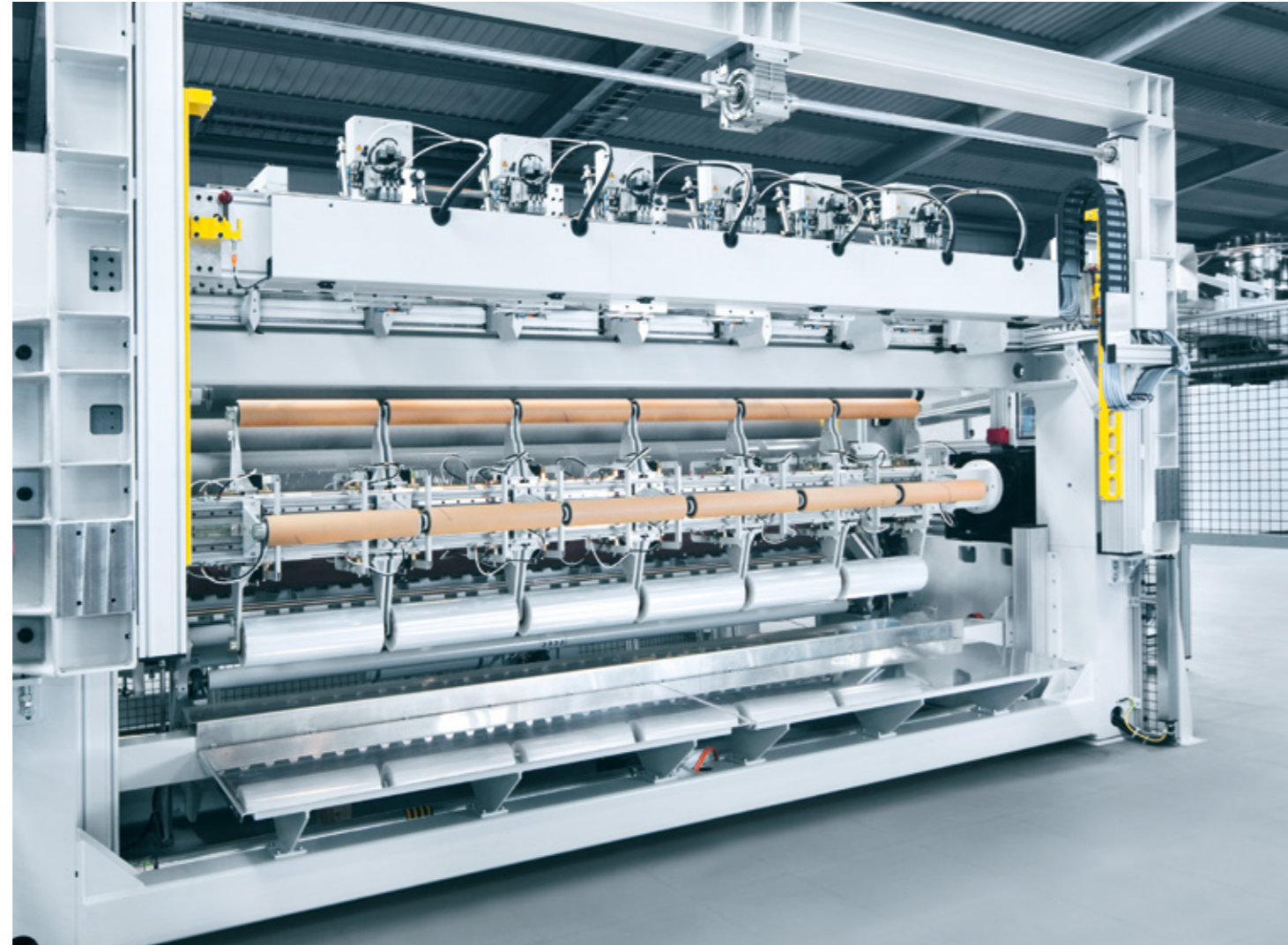

# „Workhorse“ winder W4000-2S

Simplicity, great width flexibility and top speeds for machine and jumbo rolls represent the key to high performance.

## 3-inch winding core

The film passes a satellite roll and is then wound onto a 3-inch winding core via a driven contact roll. Each turret is equipped with only two winding shafts and offers sufficient cycle time for typical machine rolls.

## Production speeds up to 800 m/min

One extremely valuable benefit is the ability to produce jumbo rolls with a maximum diameter of 425 mm and a weight of 60 kg. This winder is capable of handling actual production speeds up to 800 m/min and comes with the thin core technology. The winder W4000-2S is able to handle 2-inch and 3-inch cores with both standard and thin wall thicknesses (thin core technology).

## Your Advantages

- ▶ Single, double, and triple-turret versions
- ▶ Great width flexibility from 1,500 – 6,000 mm
- ▶ Production of machine and jumbo rolls at high speeds

This is the best selling stretch film winder which can be delivered in single, double and triple-turret versions with net film widths of 1,500 – 6,000 mm.



# „Multitalented“ winder W4000-4S

SML carefully analysed the possibility of producing a single winder design, which would meet all the current market requirements and anticipated future developments.

The result is the unique and most versatile winder W4000-4S, which is based on the company's vast experience in stretch film and the feedback received from top-level customers.

## The winder W4000-4S combines features such as:

- ▶ **4 winding shafts in each turret:** Single, double or triple-turret design, depending on the width
- ▶ **A separate contact roll for the ultimate, short tail:** Suitability for 2-inch hand rolls, 3-inch machine rolls and jumbo rolls
- ▶ **Thin core technology:** Coreless operation available, Modified edges available, K-AP technology

## Your Advantages

- ▶ All these features make the winder W4000-4S a stretch film winding benchmark.

# Single, double or triple-turret? It is your choice!

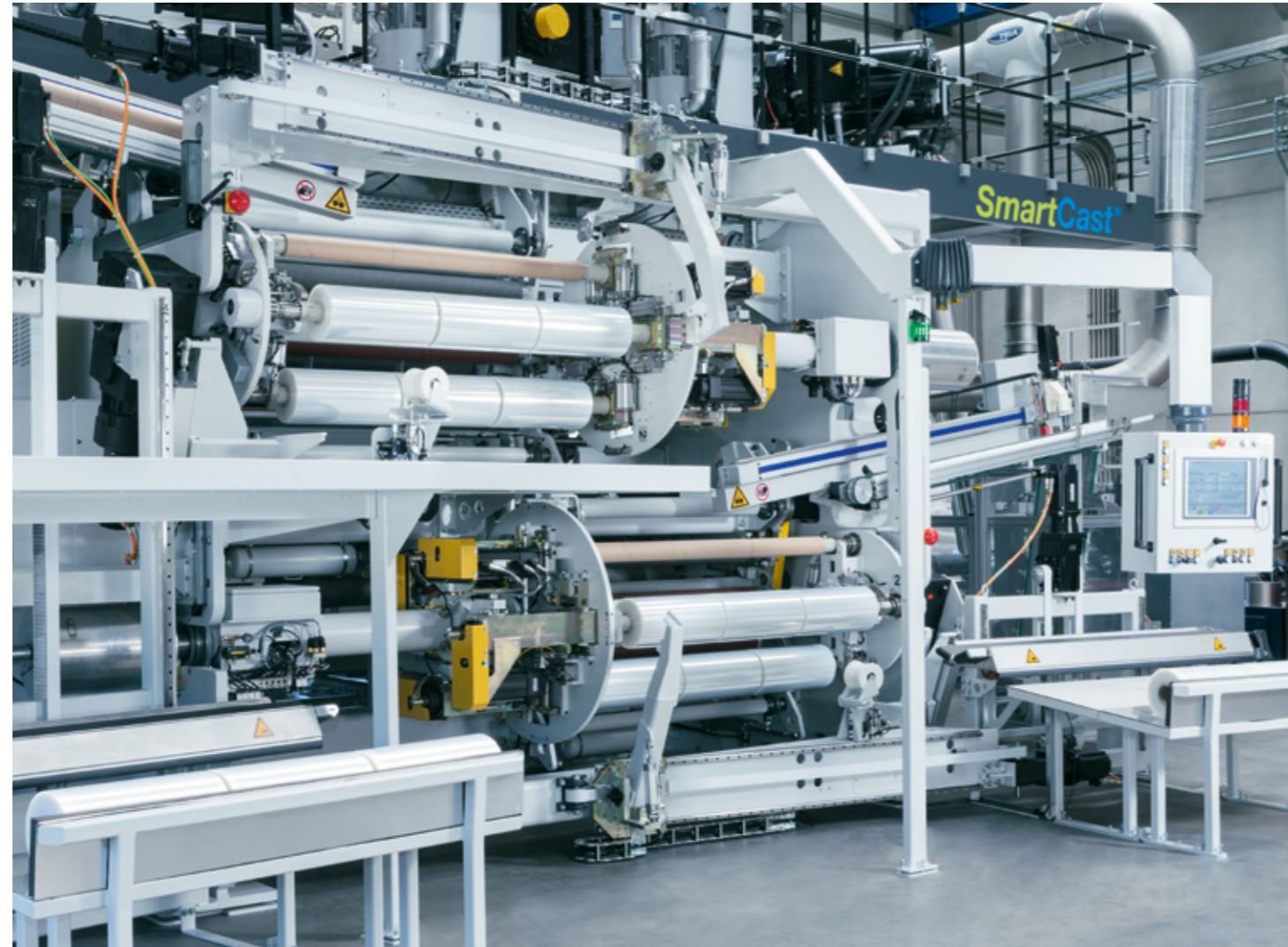

# We take a close look at film quality

SML is going one step further than many other companies by offering customers in-house quality tests in conjunction with the sample production.

We are aware that a technically flawless extrusion line is not enough. Of course, the parameters of the final product should also be perfectly balanced by choice of the adequate raw material formulations and optimised machine settings.

## Laboratory for finetuning during the process

SML therefore offers customers an optional batch test with the FPT (film performance tester) for every stretch film. Thanks to the state-of-the-art laboratory, which is located right next to SML's Technology Centre, it is possible to make quality adjustments at any time during the trial runs.

This batch test includes different procedures, which can be performed on product samples several times.

## Ultimate measurement

Both the elongation at break and the force required for this are determined using a dynamic measurement method. Furthermore, the unwind volume and unwind force can be analysed.

## Puncture measurement

Another important measure is the puncture resistance, i.e. how much force it takes to puncture the film with a rotating cone.

## Tear propagation

To measure the tear propagation resistance, a V-knife is used to pierce a hole in the tensioned film. Time is stopped until the hole becomes a film tear.

## Cling measurement

With the cling force test it is possible to measure adhesion. The film is first wound up onto a roller (as if it were on a pallet) and then pulled off again. The force required for this is then the adhesive force.

## Dart Drop with ASTM 1709

The dart drop is a method of testing puncture resistance. A dart with different weights is dropped from a tower onto the film. This determines the maximum weight that the film can withstand before it is punctured.





# Proven technology – new design

When it comes to line performance, high quality and precise interaction of the internal components are particularly important. But who says **extrusion lines** shouldn't **look great too?**



## Outstanding end-to-end service support. Reliable assistance – around the globe, at all times.

### Always at your disposal.

Our dedicated customer service team offers reliable assistance to ensure the continuous operation of any SML extrusion line at all times. Regardless of how long a system has been in operation, we offer service to every customer.

- ▶ Long term experienced SML service technicians
- ▶ Support in all ways – via telephone, video call, chat, email and in person
- ▶ On-call service from 7 am to 10 pm CET
- ▶ Remote maintenance system
- ▶ Visual assistance via smart glasses as an option
- ▶ SML service technicians on call worldwide
- ▶ Quick on-site service

### Immediate assistance.

The remote maintenance system, which is available for every SML extrusion line, makes it easier to identify potential problems and provide a quick diagnosis. In order to find solutions, our service team works closely together with other departments at SML. This way, 85 – 90 % of all malfunctions can be solved remotely.



**Our highly-skilled technicians are at your service within 24 hours throughout Europe and within 48 hours in the rest of the world.**

### Up-to-date knowledge and experience.

Our service team consists of technicians who know SML's extrusion lines inside out, having installed them themselves for many years. In order to keep their know-how up to date, all service employees continue to work regularly in everyday production. Their competence is reflected in the short reaction times to our customers' enquiries.

### Visual assistance in real time.

Through the use of smart glasses, our service team can provide real-time assistance worldwide. Whether our customers have technical problems, need help with product changes or maintenance work - they are guided step by step. This service is available for every extrusion line from SML.

# Technology that makes you smile

## **SMILE** control system

Not sure if a technology can really make you smile? Now, let the facts about **our ingenious machine** control systems **convince you.**

SMILE is SML's machine control and operation concept, allows the **highly precise synchronisation** of all the components in an **extrusion system**. If an extrusion system is the powerful body, then SMILE is the **driving soul that brings that body to life.**

### 100 % developed in-house

The dynamic controller system is entirely developed in-house and has undergone significant further development in recent years. SML's long-standing competence in the field of automation and machine control provides loads of innovative and exceptional features.

### Centralised all-in-one concept

SMILE's central control station system allows the management of each production process with a wide touch screen attached to the stretch film line. More than 1000 signals come together here, collected by many sensors, transducers and motors and transported via modern Ethernet bus systems.

This data includes sensory measurements like temperatures, speeds and pressures as well as actuator readings from valves, hydraulics, drives and positions. Thanks to SMILE, all of these components are interconnected and can be perfectly synchronised with each other. This fine-tuning allows customers to run their stretch film lines at the very best performance level.



E-container

### Intuitive machine control

At SML, we believe machine control and operation should be highly intuitive and self-explanatory. SMILE is therefore an integral part of our coherent and user-friendly overall line concept.

- ▶ A central control station system for the highest operating comfort and the visualisation of all processes
- ▶ Reduced training efforts and error rates at operator level
- ▶ Remote control, remote update and remote service (from a PC or even a smartphone)
- ▶ The system is fully multi-client and multi-user capable, different types of users can log-in simultaneously

### Optimised production efficiency

One key purpose of SMILE is the increase in the Overall Equipment Effectiveness (OEE) through optimised production processes.

- ▶ Optimised use of raw materials, preventing waste
- ▶ Faster start-up of production
- ▶ Minimised times for product change-overs, customisable assistant for product changes

### Systematic quality control

In close interaction with SML's data collection and analysis system bitWise, SMILE is an efficient tool to keep output quality stable and to optimise output properties.

- ▶ Formula recipe system to store production parameters
- ▶ Documentation and detailed reporting of production processes
- ▶ Automatic alarm functions via e-mail or text message for quick debugging

### Interconnectivity and third-party integration

SMILE has many open interfaces that allow the web-based data exchange with third-party machines and systems.

- ▶ Open to interconnecting with systems like Enterprise Resource Planning (ERP), Quality Assurance (QA) or SML's data analysis tool bitWise
- ▶ Based on open standards like HTML5 and OPC-UA, complete end-to-end process control beyond SML extrusion lines

### Tailored to specific requirements

SMILE can be tailor-made to client's specific requirements. This is blazing the way to new manufacturing concepts as well as delivering product properties.



# Stop guessing, start knowing with bit.Wise data analytics

With bitWise, SML's customers can **analyse the entire process history** of a stretch film line with a **single click**, rather than relying on **current snapshots**.

bitWise incorporates decades of experience in automation with the latest technologies in data analytics and provides for a wide range of completely new opportunities for data-driven decisions.

### In-depth view of all details

SML's stretch film lines are equipped with hundreds of data-generating sensors. BitWise records and visualises this data up to 10 times per second. In addition, each manufactured roll is provided with a QR code that can be identified again. Putting everything together, manufacturers get an in-depth view of all the details involved in a production process – both in the present and in the past.

With bitWise, customers can look back at pressures within the system components and check whether there is a correlation with other measured values such as temperature or with the laboratory results of a finished product roll.

### Always connected, even on the go

BitWise is an 100 % on-premises-solution. This means that the data remains in-house on dedicated hardware, no cloud services are required. Nevertheless, customers can access bitWise in their company network via their VPN or a remote desktop solution.

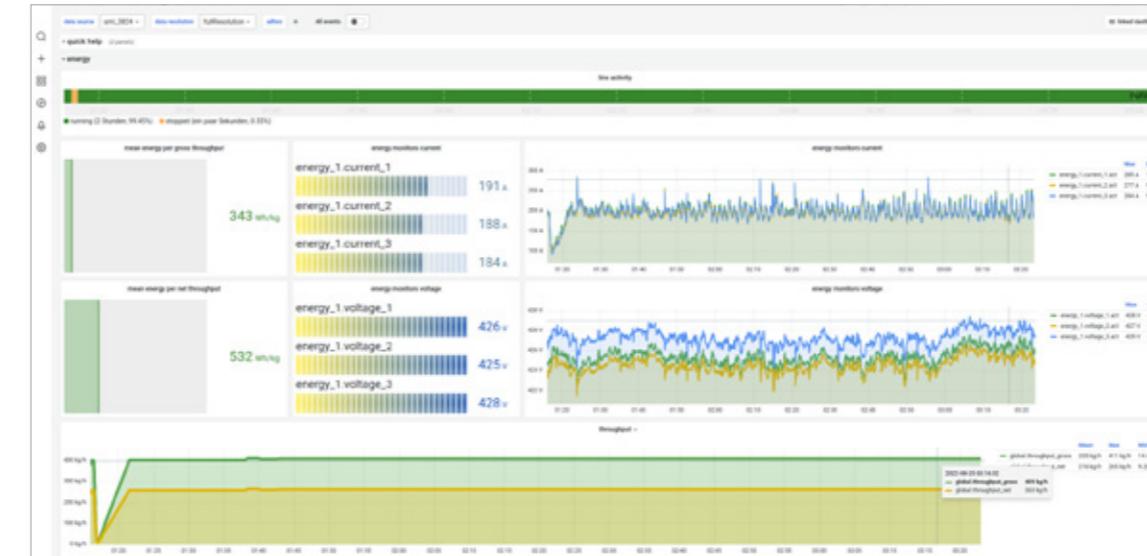

### Optimising quality

BitWise is a powerful tool to precisely optimise any aspect of the production process with a direct effect on product quality.

- ▶ Monitoring of all quality-related process parameters, allowing quick corrective action
- ▶ Comprehensive tracking and documenting of product quality
- ▶ Making quality reproducible

### Maximising output

Recorded, aggregated and visualised data by bitWise helps to raise overall line utilisation and delivers a faster return on investment (ROI).

- ▶ Discovering hidden or unused output capacities
- ▶ Preventing downtimes by detecting potential problems at an early stage
- ▶ Minimising maintenance times through optimised scheduling and structured access to documentation and service support

### Minimising production costs

bitWise is the central tool to measure and visualise all production related costs. It forms a strong and reliable basis for the continuous cost-optimisation.

- ▶ Detailed monitoring and reporting of energy and raw material consumption
- ▶ In-depth optimising, tracking and reporting of Overall Equipment Effectiveness (OEE)
- ▶ Full end-to-end cost transparency through third-party integration

### Open for vertical integration

At SML we understand that cast film lines represent a key part in a wider production chain. For end-to-end optimisation, bitWise therefore supports data exchange and vertical integration with third-party systems such as Manufacturing Execution Systems (MES), Enterprise Resource Planning (ERP) or Quality Assurance (QA). Customers can simply retrieve the data from the system.



### Choose your perfect interface

As with most technologies developed by SML, bitWise is highly customisable. The remote system can be retrofitted to all existing SML cast film lines.



Analyses  
Development  
Pre-tested Performance  
Delivery on Time  
Service Support  
Customer Satisfaction

► **SML - Machinery Far East Sdn Bhd**  
(1029958-P)  
1201 Block B, Menara Amcorp  
No.18 Jalan Persiaran Barat  
46050 Petaling Jaya  
Selangor Darul Ehsan,  
Selangor, Malaysia  
Phone: +60 3 7955 9098  
Fax: +60 3 7955 9981  
E-mail: yen@sml.at

► **SML - Beijing Office**  
Unit 1410, Landmark Tower  
No. 8 North Dongsanhuan Road  
Chaoyang District  
100004 Beijing, P.R. of China  
Phone: +86 10 6590 0946  
Fax: +86 10 6590 0949  
E-mail: sml@sml.bj.cn

► **SML - North America Service Inc.**  
Suite 204  
85 Eastern Avenue  
Gloucester MA 01930  
USA  
Phone: + 1 978 281 0560  
E-mail: jom@sml.at



[www.sml.at](http://www.sml.at)

The image shows a large, modern industrial building with a white facade. The SML logo is prominently displayed on the upper part of the building, rendered in a light blue, three-dimensional font. The building has large glass windows and a dark lower section. The sky is clear and blue.

► **SML - Head Office**

SML Maschinengesellschaft mbH  
Gewerbepark Ost 32  
4846 Redlham, Austria  
Phone: +43 7673 90999 0  
E-mail: [sml@sml.at](mailto:sml@sml.at)  
[www.sml.at](http://www.sml.at)

**Follow Your Instinct –  
choose SML!**